



□ 92x92x32 mm



Frame: Thermoplastic PBT UL 94V-0
Impeller: Thermoplastic PBT 94V-0
Ambient Temperature Range: -10°C ~ +70°C
Bearing: Ball or Sleeve
Termination: Terminals or Lead wire
Weight: 195 g

Dimension (units:mm)

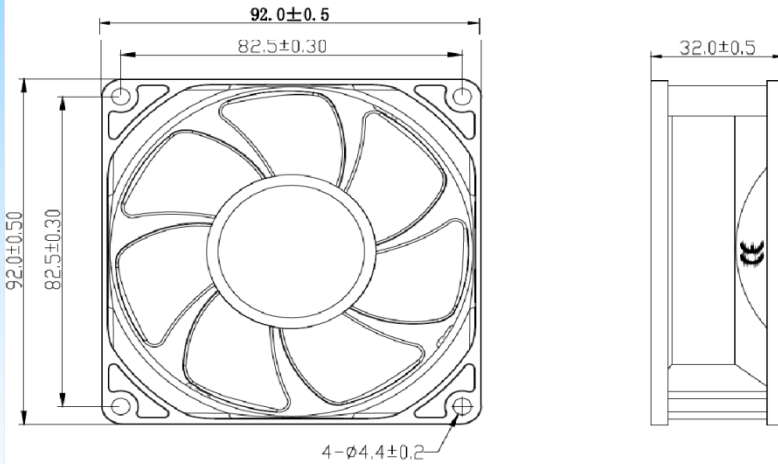

Characteristic Curves

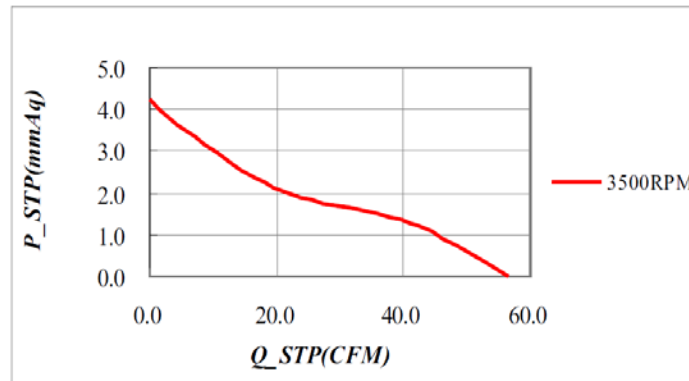

SPECIFICATION

Model	Voltage (V)	Operating Range(V)	Freq. (Hz)	Power (W)	Speed (RPM)	Air Flow (CFM)	Air Flow (m3/min)	Pressure (in-H2O)	Noise (dB)
CYE10932HB	110	80-135	50/60	6	3500	56	1.60	0.17	43
CYE20932HB	220	180-265							

- If you want another RPM or Voltage or Functions which not in the list. Please contact with us. We can customize for you.
- Specifications are subject to change without notice.

EC Axial Fan